

## Alaska Cruise – Alaska Fjord and Glaciers

### 2020 Dates & Prices

#### Wilderness Discoverer ---

Date	Navigator	Trailblazer	Pathfinder	Explorer
May 30, 2020	\$4,195	\$4,995	\$5,395	\$7,195
Jun 6, 2020*	\$4,195	\$4,995	\$5,395	\$7,195
Jun 27, 2020	\$4,695	\$5,495	\$5,995	\$7,795
Jul 4, 2020*	\$4,695	\$5,495	\$5,995	\$7,795
Jul 25, 2020	\$4,695	\$5,495	\$5,995	\$7,795
Aug 1, 2020*	\$4,695	\$5,495	\$5,995	\$7,795
Aug 22, 2020	\$4,195	\$4,995	\$5,395	\$7,195
Aug 29, 2020*	\$4,195	\$4,995	\$5,395	\$7,195

#### Wilderness Explorer ---

Date	Navigator	Trailblazer	Pathfinder	Explorer
Apr 18, 2020*	\$3,195	\$3,995	\$4,395	\$5,495
May 9, 2020	\$4,195	\$4,995	\$5,395	\$6,395
May 16, 2020*	\$4,195	\$4,995	\$5,395	\$6,395
Jun 6, 2020	\$4,195	\$4,995	\$5,395	\$6,395
Jun 13, 2020*	\$4,195	\$4,995	\$5,395	\$6,395
Jul 4, 2020	\$4,695	\$5,495	\$5,995	\$7,195
Jul 11, 2020*	\$4,695	\$5,495	\$5,995	\$7,195
Aug 1, 2020	\$4,695	\$5,495	\$5,995	\$7,195
Aug 8, 2020*	\$4,695	\$5,495	\$5,995	\$7,195
Aug 29, 2020	\$4,195	\$4,995	\$5,395	\$6,395
Sep 5, 2020*	\$4,195	\$4,995	\$5,395	\$6,395
Sep 19, 2020	\$3,195	\$3,995	\$4,395	\$5,495

#### Wilderness Adventurer

Date	Navigator	Trailblazer	Pathfinder
Sep 26, 2020	\$3,195	\$4,095	\$4,495

\*These dates are a reverse itinerary starting in Ketchikan on Day 1 and ending in Juneau on Day 8.

**Cabin Price does not include:**

Port taxes/fees are in addition to your cruise fare:

- **\$375 per person** (subject to change)

Rates are per person based on double occupancy

All departures are seven nights duration. Rates are in US dollars not including port taxes and fees.

SINGLE Rates - available in designated cabins at 175% of the per person double rate

**Want more time in Alaska?** How about combining the two Alaska cruises "Northern Passages & Glacier Bay" with the "Fjords & Glaciers" cruise to make a **two week Ultimate Expedition**. Cruises will either start in Sitka and end in Ketchikan or reverse with a full day in Juneau in the middle. Call REI Adventures for special pricing on this incredible 14 night cruise. 1 800-622-2236.

**Special Payment, Cancellation, and Transfer Policy**

REI Adventures standard payment and cancellation policies do not apply.

A \$750 deposit per person is due at time of sign up. Final payment is due 90 days before departure.

- If cancelling 121 or more days prior to departure - \$375 cancel fee per person
- If cancelling 120-91 days prior to departure - \$750 cancel fee per person
- If cancelling inside 90 days prior to departure – 100% of the cruise cost is nonrefundable

A request to transfer a reservation is subject to the same fees outlined above for cancellations.

**Accommodations**

The "Wilderness" vessels are expedition ships capable of nimble exploration through nature's most dramatic hideaways. The shallow draft and hull design allow easy access to Southeast Alaska's wildlife-rich shores and glacially-fed inlets and serve as ideal "launching pads" for an exciting array of daily adventure excursions. The interior spaces offer contemporary colors that complement the wilderness outside and the public and private spaces are loaded with amenities.

Three accessible decks are fully equipped for comfort and action. There is a sun deck, an on-deck hot tub, fitness equipment and lots of room for outside observations for the ever-changing wildlife and scenery. The EZ Dock kayak launch platform makes getting in the water a cinch for experienced and novice kayakers. On-board are tandem-sea kayaks, stand-up paddle boards, inflatable skiffs and yoga mats.

Cabins offer a private bathroom with a shower. A collection of eco-friendly toiletries (conditioning shampoo and body wash), towels, hair dryer, iPod docking station, and television/DVD player (for video viewing only) is provided.

Please note: Most cabins on the Wilderness Explorer have fixed twin beds and will not be available to make into one queen bed.

**See below for deck plans**

# Wilderness Discoverer Deck Plans



Sun Deck

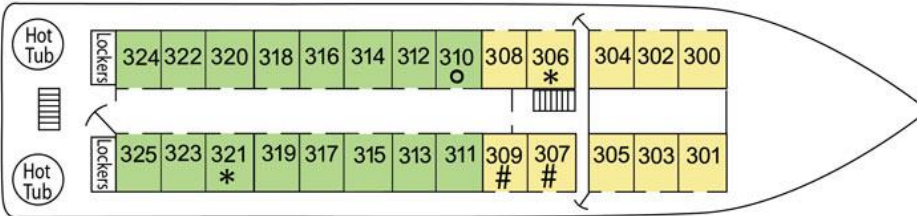

Observation Deck

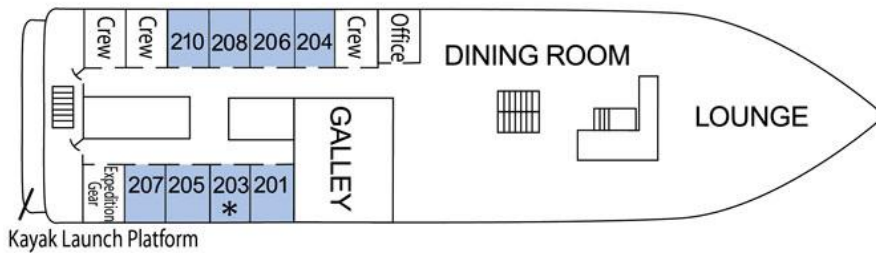

Main Deck

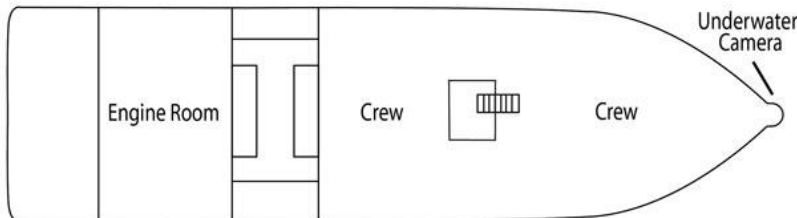

Below Deck

#Double or Triple Accommodation \*Single or Double Accommodation

o Fixed Twin Beds

76 Guests – Common to all cabins are: Flat-screen TV/DVD; iPod docking station; air conditioning; private bath with shower; view windows.

Navigator	Trailblazer	Pathfinder	Explorer
-----------	-------------	------------	----------

# Wilderness Explorer Deck Plans

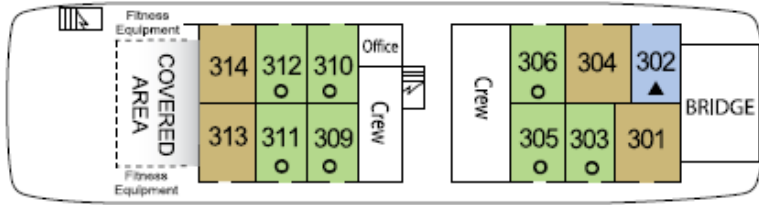

Sun Deck

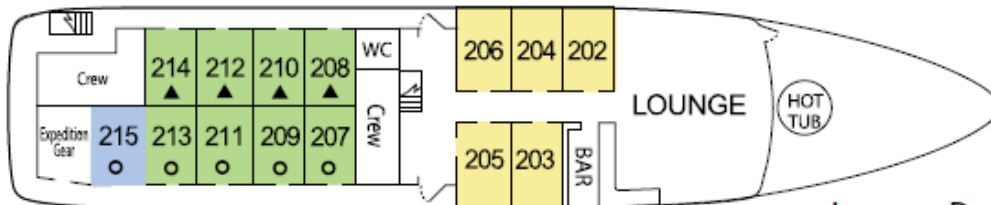

Lounge Deck

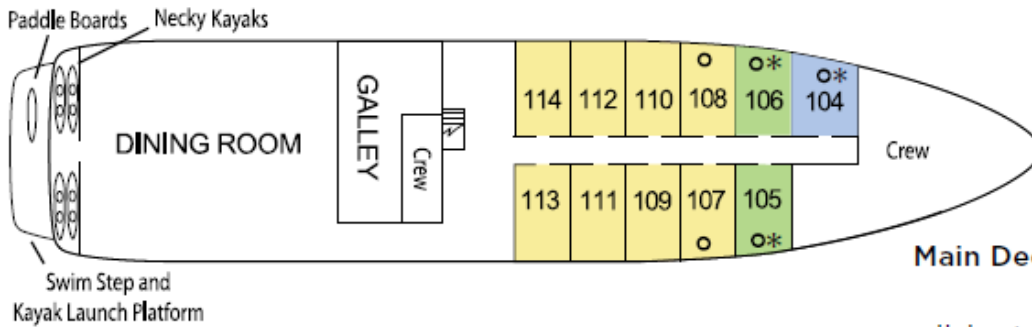

Main Deck

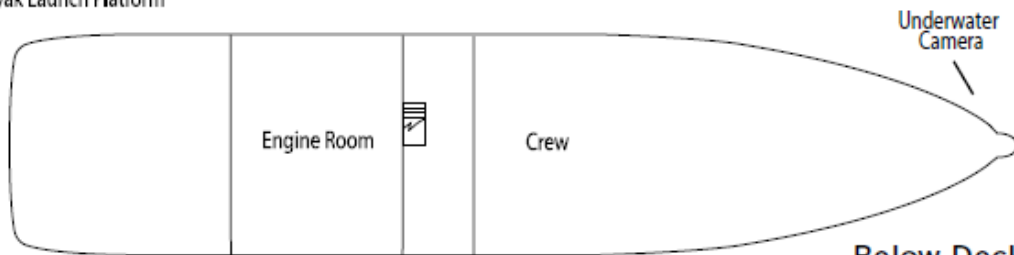

Below Deck

▲ Fixed Queen Bed \* Single Accommodation ○ Fixed Twin Beds

74 Guests – Common to all cabins are: Flat-screen TV/DVD; iPod docking station; air conditioning; private bath with shower; view windows.



# Wilderness Adventurer Deck Plans

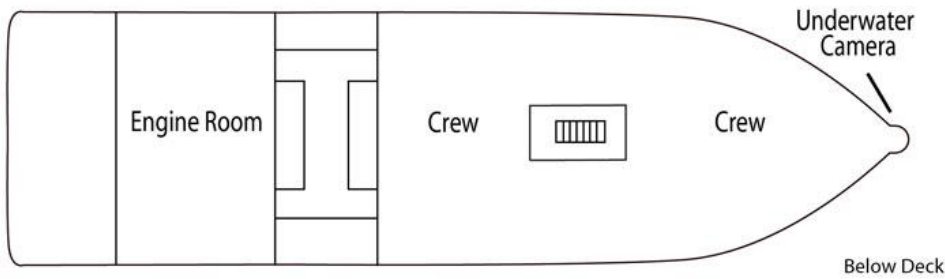
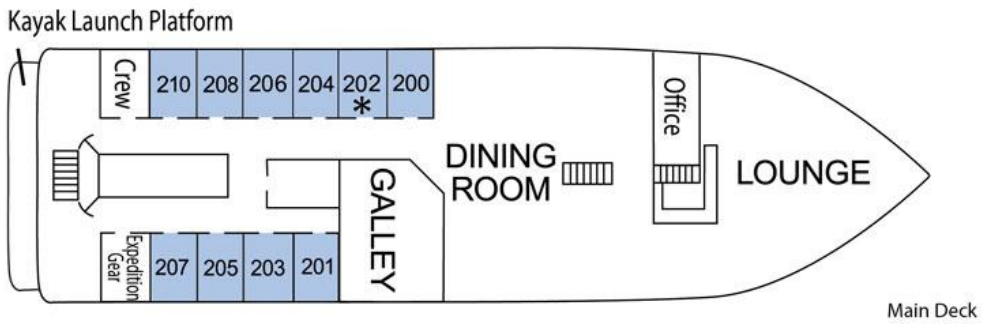
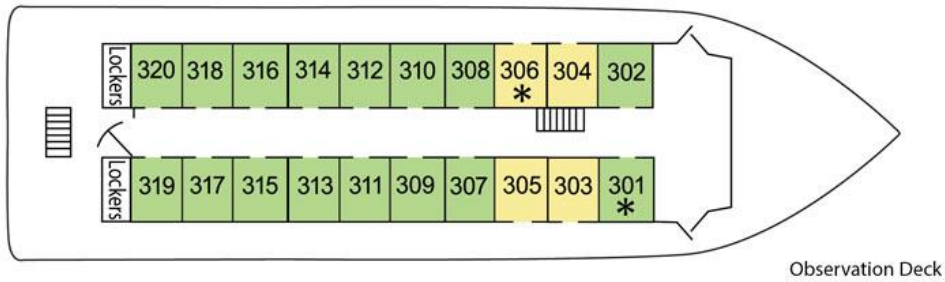
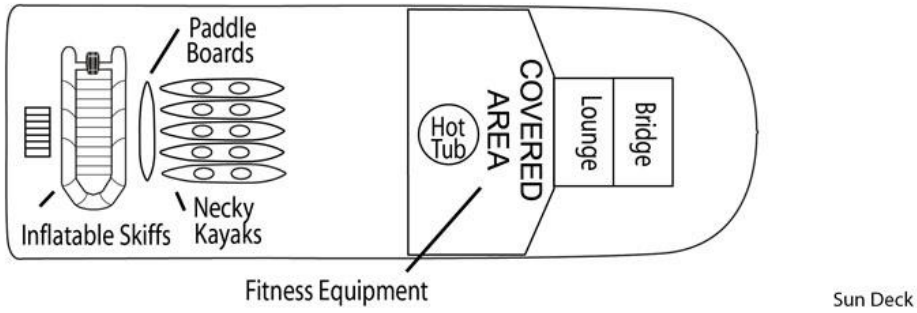

\*Single or Double Accommodation

60 Guests – Common to all cabins are: Flat-screen TV/DVD; iPod docking station; private bath with shower; a view window.

Navigator	Trailblazer	Pathfinder
-----------	-------------	------------